



Operator's Safety and Service Manual

Cordless Sprayer

Model: **C100WO**



SMK Industries Inc

12839 Carpenter Trail
Carlisle, IA 50047
Phone: 515-202-0052

Email: john@smksprayers.com
Web: www.smksprayers.com

Troubleshooting	12
Maintenance	13
Service	13
Replacement parts	13

INTRODUCTION

You have purchased a quality SMK product, proudly made in the USA. If you use and maintain your SMK product for what it is intended, you will enjoy many years of safe, reliable service.

The SMK "C100" portable sprayer utilizes the popular SHURflo® pump technology. SHURflo® pumps provide industry standard Viton® valves and Geolast or EPDM diaphragms and DeWalt rechargeable 12V – 18V batteries.

Page 1

SMK reserves the right to make changes to this manual without notice

Table of Contents

Safety Information	2
Introduction	2
Safety Precautions	3-4
Warranty	5
Proof of purchase	6
Specifications	6
Operation	7
Introduction	7
Before operating the sprayer	7
Contents of carton	7
Contents illustration	8
Assembly	8-9
Operating the sprayer	10
Clean up	10
Chemical compatibility	11

Maintenance

Maintenance of the unit is normally not required with the exception of thoroughly cleaning the entire unit, by flushing the internal components (see clean up on page 11) and cleaning the exterior of the case, after each use.

Service



Service on this unit both within and after the warranty period should be performed only by an authorized service center. To find the service center nearest you Call 1-515-202-0052

Replacement Parts

For a list of replaceable parts, please call 515-202-0052 for assistance.

Safety Information

Introduction

 This Safety Alert Symbol is used to call attention to items or operations which may be dangerous to those operating or working with this equipment. The symbol can be found throughout this manual and on the unit. Please read these warning and cautions carefully before attempting to operate the unit. Make sure every individual who operates or works with this equipment is familiar with all safety precautions.



GENERAL WARNING: Indicates information important to the proper operation of the equipment. Failure to observe may result in damage to the equipment and/ or severe bodily injury or death.

 **CAUTION** 

GENERAL CAUTION: Indicates information important to the proper operation of the equipment. Failure to observe may result in damage to the equipment.





REFERENCES: For details on safety rules and regulations in the United States, contact your local Occupational Safety and Health Administration (OSHA) office. Equipment operated in other countries must be operated and serviced in accordance and compliance with any an all safety requirements of that country. The publication of these safety precautions is done for your information. SMK does not by the publication of these precautions, imply or in any way represent that these are the sum of all dangers present near SMK equipment. If you are operating SMK equipment, it is your responsibility to insure that such operation is in full accordance with all applicable safety requirements and codes. All requirements of the United States Federal Occupational Safety and Health Administration Act must be me when operated in areas that are under the jurisdiction of that United States Department.







Safety Decals

Carefully read and follow all safety decals. Keep them in good condition. If decals become damaged, replace as required. Decals are available from authorized distributors.

Safety Precautions

 **WARNING** 

-  Before attempting to operate the unit, read and understand all safety precautions and warnings.
-  Do Not spray gasoline or other flammable or combustive materials in this unit
-  Do Not use this unit in a combustive environment.
-  Do not use the unit when tired, ill, or under the influence of alcohol, drugs or medication.

-  Inspect unit before each use for loose, broken, cracked, split, or damaged parts. Do Not operate the unit with loose or damaged component parts.
-  Always wear safety glasses or goggles that are marked with ANSI Z87
-  Use only in daylight or good artificial light.
-  Never use unit without the proper factory authorized accessories attached. When using the unit, ensure that the sprayer discharge hose is securely attached.
-  Do not use Acetone, Lacquers, Lacquer thinners, or Acetate in this unit. These are flammable liquids and will also permanently damage the internal components of the sprayers pump.
-  Do not modify the unit
-  Use approved batteries only

Trouble shooting

SPRAYER WILL NOT START

- ✓ If battery is properly seated and fully charged
- ✓ If On/Off switch is in the off position
- ✓ If fuse is blown

SPRAYER WILL NOT PRIME

- ✓ If pickup tube or discharge hose for restrictions
- ✓ If you are out of product
- ✓ For properly charged battery

- ✓ For vacuum leak in pickup tube

SPRAYER OUTPUT VOLUME REDUCED

- ✓ If pickup tube or discharge hose for restrictions
- ✓ Sprayer wand and wand tip for restrictions
- ✓ Material is too high in viscosity
- ✓ Material is too cold

EXCESSIVE VIBRATION ON SPRAYER

- ✓ For foreign debris on sprayer assembly or bucket
- ✓ For loose hardware on sprayer assembly

Page 12

Chemical Compatibility

Refer to the following website for a chemical compatibility chart to ensure that the material you wish to spray is compatible with the pump components (Viton®, Santoprene® and Polypropylene).

www.shurflo.com/pdf/industry/CCChart.pdf



CAUTION



IT IS YOUR RESPONSIBILITY TO ENSURE THAT THE MATERIAL YOU ARE SPRAYING IS COMPATIBLE WITH THE PUMPS COMPONENTS.

Page 11







CAUTION



 Due to the nature of this unit, it is imperative the unit is properly cleaned and flushed using the

appropriate fluids as recommended by the chemical/compound manufacturer. Failure to clean the unit after each use will result in the failure of the unit and will result in loss of warranty coverage.

-  Do not assume fluid compatibility. If the fluid is improperly matched to the pumps elastomers, a leak or damage to the pump may occur. Be certain that the material being sprayed is compatible with Viton®, Santoprene®, and Polypropolyne.
-  Attempting to spray liquids below the manufactures recommended temperatures may affect the sprayers ability to adequately perform. Low temperatures may affect your materials viscosity.
-  Do not leave material in unit in between uses
-  Do not submerge or expose to excessive moisture

Warranty



CAUTION



DO NOT ATTEMPT TO SERVICE THE UNIT, YOU WILL VOID THE WARRANTY. CALL THE SERVICE CENTER.

SMK Industries warrants this product to be free from material or workmanship defects for a period of 60 days from the date of manufacture. Alternatively, 60 days from purchase, not to exceed two years from date of manufacture.

Warranty does not apply when:

- Unit is not used within the guidelines of this manual.
- Product or Parts are used or installed outside the SMK authorized service center.
- Incompatible fluids are used.
- Misuse or Abuse.
- Improper or inadequate cleaning of unit after use.

In the event you need to utilize this warranty, the product or part must be returned for examination, postage prepaid, direct to the SMK Industries service center as instructed by calling 515-202-0052 . Proof of purchase date and an explanation of the claim must accompany the merchandise. If inspection discloses a defect, SMK will either repair or replace the product with like equipment at SMK's expense. If no defect is found during the inspection, or if the defect resulted from causes not within the scope of SMK's limited warranty, then the user must assume all costs incurred returning, repairing, and/or storing the product.

All products and parts will be tested using SMK testing criteria. Units found to be damaged, altered or otherwise mistreated will not be covered under this warranty. Units

found not to be defective are subject to charges to be paid by the returnee.

Page 5

Operating the Sprayer

Keeping all safety and operating measures in mind You are now ready to begin spraying. By squeezing the trigger handle you will activate the sprayer to begin “priming” the pump.

The pump is self priming and will not be damaged by running dry. Priming time will vary depending on the fluid viscosity and temperature. Priming should only take a few seconds, depending on the material. Be certain the fluid being pumped is compatible with the pump materials, Viton®, Geolast, EPDM and Polypropylene. For a partial list of compatible fluids see appendix A. If it is not listed or you are unsure, contact your chemical supplier. The pump is intended for continuous or intermittent duty when the proper operating criteria are met.

NOTE: “Intermittent Duty” is defined as; operated and/or frequently started within a period of time that would cause the motor to reach its maximum thermal limits. Once the maximum thermal limit is obtained, a thermal breaker switch will interrupt operation until the motor cools down to normal operating temperature, then it will automatically reset and resume operation.

Pump may cycle on and off at varying intervals depending on viscosity and temperature of the material being sprayed.

Clean up



CAUTION



As with any type of sprayer, this unit will not function satisfactorily if the unit is not clean. Thoroughly clean the

sprayer after EACH use by completely flushing the unit, including all hoses and wand. The cleaning agent should be whatever is recommended by the manufacturer of the material that you are spraying. Pump the cleaning agent through the sprayer until all traces of the previously sprayed material has been removed from the unit.

Page 10

3. Remove the spout cover from the 5 gallon bucket of material that you intend to spray (do not pull out the spout tube).
4. Set the sprayer unit on top of the bucket by guiding the inlet tube into the pouring spout of the bucket lid
5. Set the power switch on the motor to the off position
6. Insert the battery into the receptacle, when fully inserted it will contact the sprayer housing.
7. Check the sprayer trigger handle to make sure the lever is not locked in the open/ on position.
8. You are now ready to begin spraying your material.

SMK shall in no event be liable for death, injuries to persons or property or for incidental, contingent, special or consequential damages of any kind by the reason of use or sale of any defective product or part. This limited warranty covers units distributed in the United States of America only.

This limited warranty is in lieu of all other warranties, expressed or implied, and no other person is authorized to give any other warranty or assume obligation or liability on behalf of SMK Industries, Inc.

Products and parts must be flushed free of all fluids prior to returning to SMK for warranty inspection.

PROOF OF PURCHASE

Please retain your dated sales receipt as proof of purchase to validate the warranty period.

SPECIFICATIONS

Integral pump	SHURflo® Model: SLV10-AA48
Pump motor voltage	12 Volt
Chassis	Powder coated steel
Trigger	Chapin
Wand	Chapin
Wand tips	Chapin
Approved batteries	Dewalt® 12V – 18V
	or Interstate® brand 12V- 18V

Operation

Before Operating your Sprayer



WARNING



Carefully read through this entire manual before attempting to use your new product. Pay close attention to the safety alerts symbols, warnings and cautions.

Contents of Carton

Contents of Carton include:

1. Cordless sprayer assembly
2. Wand assembly with hose
3. Suction tube
4. Owners manual

(Battery and bucket not included)

Examine all parts to ensure that everything is accounted for and no damage has occurred during shipment. Any damaged or missing part must be replaced before attempting to use this product.

page 7

Assembly

To prepare the unit for operation, assemble the sprayer as follows:

1. Attach the sprayer hose assembly to the garden hose Thread fitting located on the side of the unit base plate.

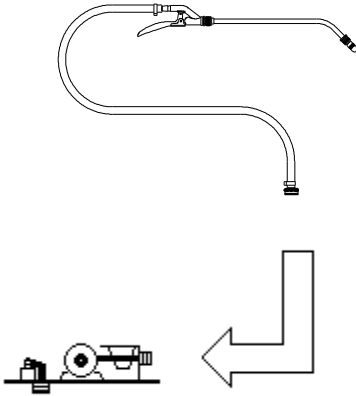

2. Attach the inlet tube to the fitting located on the bottom of the sprayer base plate.

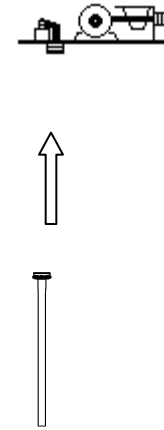

Page 8